

Lightning counters

CF-01, P8011



P8011



CF-01

Lightning counters are designed to detect and record the impulse current conducted by the down conductor of the lightning protection system (LPS) or by the earthing wire of a protective surge protection (SPD).

These units are useful to assess the stress of the protection devices, in order to perform their efficient maintenance.

2 versions are available :

CF-01

This device counts each impulse current greater than 0.3 kA. It is designed for outdoor or indoor application and is mounted directly on the down conductor with the supplied flange. A reset of the counter could be perform by returning the unit in factory.

This lightning counter is also available with solar supply (outdoor application).

P8011

This version is in compliance with NF C 17-106 guide and counts lightning and surge currents from 0.3 to 100 kA. The 6-digit LED display allows an easy reading whatever the conditions. P8011 counter can be itself controlled by an dedicated tester in case of maintenance cycle required.

- **Lightning current counters**
- **For LPS and SPD**
- **Outdoor or indoor application**
- **Compliance with NF C17-106 std.**

Installation

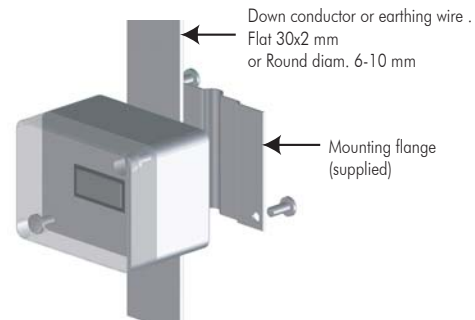

Characteristics

CITEL part number	CF-01	P8011
Description	Lightning counters outdoors or indoor	Lightning counters outdoor
Minimum current sensibility	0.3 kA	0.3 kA
Max. admissible impulse current	100 kA	100 kA
Maximum numbers of events	999	999999
Type d'affichage	LCD	LED
Dimensions	65x50x45 mm	146x95x42 mm
Weight	0.15 kg	0.5 kg
Enclosure	Polycarbonate IP54	Polycarbonate IP67
Power supply	internal by battery	internal by battery
Life expectancy (before battery replacement)	> 10 years	> 10 years
Mounting	by flange on round (Ø 6 to 10) or flat (30x2) conductor	by flange on round (Ø 6 to 10) or flat (30x2) conductor
Compliance	NFC 17-106	NFC 17-106