



CITEL

Type 2 (or 3) AC surge protector - 3-phase

DAC15CS-30-275



- ▶ Compact 3-phase Type 2 (or 3) surge protector
- ▶ In: 5 kA
- ▶ Imax: 15 kA
- ▶ Common mode
- ▶ Pluggable module
- ▶ Remote signaling
- ▶ IEC 61643-11, EN 61643-11, UL1449 ed.5 compliance

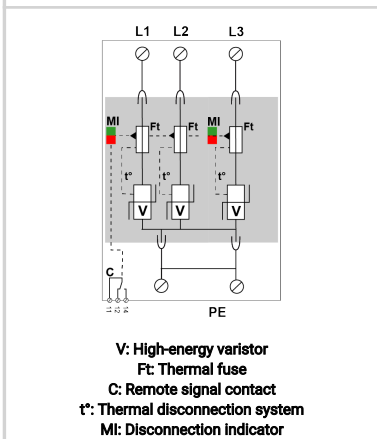
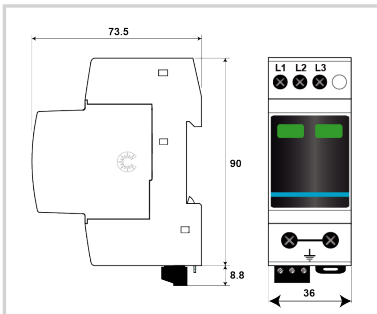

Electrical Characteristics

SPD type	IEC	2+3
Network		230/400 V
AC system		TN
Max. AC operating voltage	Uc	275 Vac
Temporary Over Voltage (TOV) Characteristics - 5 sec. Without disconnection	UT	335 Vac withstand
Temporary Over Voltage (TOV) Characteristics - 120 mn Without disconnection or with safety disconnection	UT	440 Vac disconnection
Residual Current Leakage current to Ground	Ipe	< 1 mA
Follow current	If	None
Nominal discharge current 15 x 8/20 μs impulses	In	5 kA
Max. discharge current max. withstand @ 8/20 μs by pole	Imax	15 kA
Total Maximum discharge current max. total withstand @ 8/20 μs	Imax Total	60 kA
Withstand on Combination waveform IEC 61643-11 Class III test: 1.2/50μs - 8/20μs	Uoc	10 kV
Protection mode(s)		L/PE
Protection level N/PE @ In (8/20μs)	Up N/PE	0.9 kV
Protection level L/PE @ In (8/20μs)	Up L/PE	1.2 kV
Admissible short-circuit current	Iscsr	10 000 A

Mechanical Characteristics

Technology		MOV
SPD configuration		3-phase
Connection to Network		By screw terminals: L/N = 1.5-10mm ² (16mm ² rigid) or PE = 2.5-25mm ² (35mm ² rigid)
Format		Plug-in modular box
Mounting		Symmetrical rail 35 mm (EN 60715)
Housing material		Thermoplastic UL94 V-0
Operating temperature	Tu	-40/+85°C
Protection rating		IP20
Failsafe mode		Disconnection from AC network
Disconnection indicator		2 mechanical indicators - Red/Green
Spare module(s)		MDAC15C-30-275
Remote signaling of disconnection		Output on changeover contact
Wiring for remote signaling		1.5 mm ² max.
Max. Voltage/Current for remote signaling		250 V / 0.5 A (AC) / 30 V / 3 A (DC)
Dimensions		See diagram - 2TE (EN43880)
Weight		0.221 kg

Disconnectors

Thermal disconnecter		Internal
Installation ground fault breaker		Type 'S' or delayed
Back-up protection device		20 A min. - 125 A max. - Fuses type gG

Standards

Standards compliance		IEC 61643-11 / EN 61643-11 / UL1449 ed.5
----------------------	--	--

Part number

821610223

